

IC/L **50Hz**
SERIES

Submersible Dewatering Pumps
Large Volume Submersible Pumps



IC-215



IC-32B~45B



IC(W-Well Type)



IC-48~610

IC

FEATURES

- The internal casting is treated with High solids Epoxy coating, which can improve the anti-corrosion and extend the product lifetime.
- Standard design, incorporating a dry motor with thermal Auto-cut Protector that prevents the motor from over heating. Equipped with a cast iron motor frame for a faster heat dissipation. As well as an abrasion resistant mechanical seal and an additional oil seal.
- Water cooled motor to ensure a long life in continuous and intermittent operation, with high efficiency and energy savings.
- An exceptional High-lift and suction impeller design, which allows for dewatering of underground or circulating water applications.
- For above or below surface water applications; the IC pump strainer can be easily removed and replaced with a check valve, which allows for dewatering up to max. 8m deep of underground water and water circulation applications. (W-Well Type)
- New casing cover, with metric thread bolt hole that is easier for valve and adapter connection.
- The chrome steel impeller has been adopted for IC-32B~610, with hardness of HRC 25~30; better anti-corrosion, and extended product lifetime.
- High solids Epoxy coating prolong metals from corrosion and oxidization



IC-215



IC-32B~IC-610

APPLICATIONS

- Aquiculture water supply and drainage.
- Water supply for agricultural irrigation systems and underground water pumping.
- Landscape, water feature and horticulture irrigation.
- Extraction of water from rivers, lakes and reservoirs.

PRODUCT NOMENCLATURE

IC	—	3		2		B
Type		Discharge inch		HP		Style

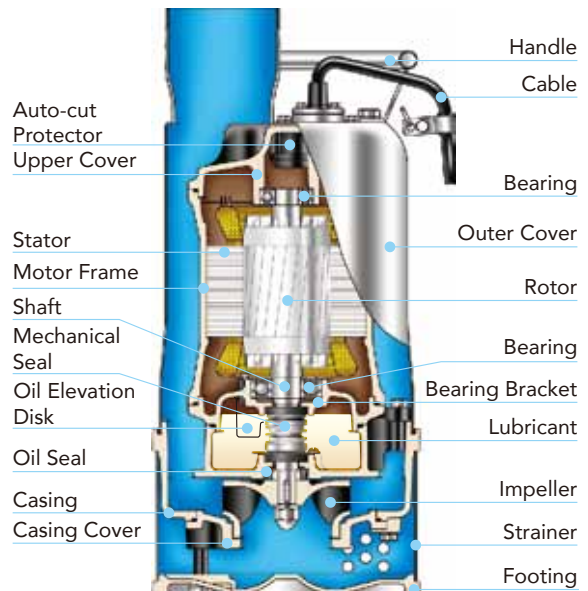



PERFORMANCE CURVES

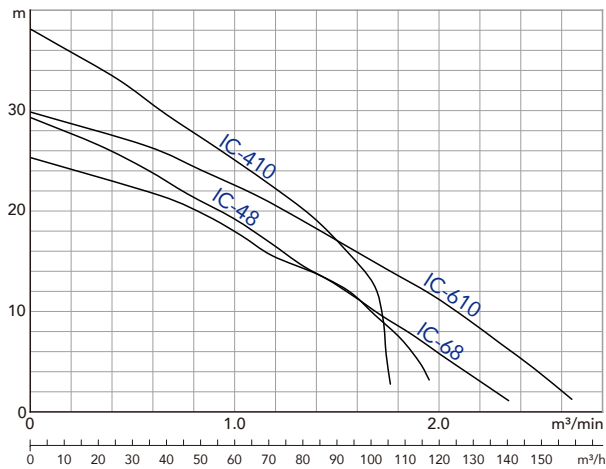
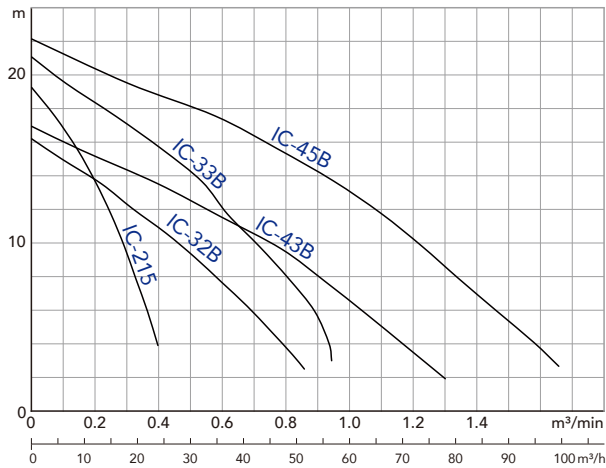

SPECIFICATIONS

Item	Description	
Limits of Use	Liquid Temp.	0~40°C (32~104°F)
	Applications	Agriculture irrigation • Circulating water • Dewatering
Type	Frequency	50Hz
	Motor	2P (3000rpm) • Dry Motor
	Insulation	Class F (1.5~5HP) • Class H (7.5~10HP)
	Protection	IP68
	Protector	Auto-cut
	Bearing	Ball type
	M.seal	Double M.seals
Material	Impeller	Close
	Outer Cover	SUS304
	Upper Cover	FC200
	Motor Frame	SUS304 (1.5HP) • FC200 (2~10HP)
	Shaft	SUS403 (1.5~3HP) • SUS304 (5~10HP)
	M.seal	CA/CE & SiC/SiC
	Casing	FC200
Optional	Impeller	BC (1.5HP) • Chrome Steel (2~10HP)
	Cable	VCT or H07RN-F or SJOW/SOW
Optional	Pumps can be customized to fit specifications	

PERFORMANCE SPECS.

Model	Output HP(kW)	Discharge Inch(mm)	Phase Ø	Start Method	Head m	Standard		Solid Passage mm	Weight kg		Dimensions mm				
						m³/min	m³/h		1Ø	3Ø	A	B		C	
IC-215	1.5(1.1)	2"(50)	1	Capacitor	13.5	0.2	12	3.5	28	24	210	431	372	482	423
IC-32B	2(1.5)	3"(80)	1	Capacitor	9.5	0.5	30	10	40	36	235	548	503	511	466
IC-33B	3(2.2)	3"(80)	1	Capacitor	14	0.5	30	10	45	39	235	578	503	541	466
IC-43B	3(2.2)	3.5"(90) 4"(100)	1	Capacitor	9.5	0.8	48	10	45	39	235	593	518	556	481
IC-45B	5(3.7)	3.5"(90) 4"(100)	3	Direct	13	1.0	60	10	-	44	235	-	548	-	511
IC-48	7.5(5.5)	4"(100)	3	Direct	19	1.0	60	10	-	75	286	-	550	-	610
IC-68	7.5(5.5)	6"(150)	3	Direct	12	1.5	90	10	-	78	286	-	550	-	610
IC-410	10(7.5)	4"(100)	3	Direct	25	1.0	60	10	-	80	286	-	550	-	610
IC-610	10(7.5)	6"(150)	3	Direct	17	1.5	90	10	-	81	286	-	550	-	610

Note : Weight Without Cable & Outlet,
*3.5" (90mm) optional by request.

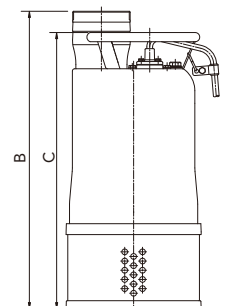
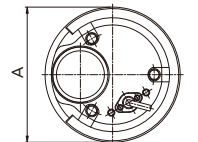



L-405A/41A



L-62A/63A



L-200A/250A



L-300B



L-200A/250A
Inside view

FEATURES

- Large flow capacities achieved with almost no vibration, or noise, by use of the axial and mix flow design.
- HIGH-QUALITY BRONZE : Widely acclaimed for its ability to withstand corrosion, even to the erosion of sea water and brine and is proved to be able to substantially extend time to service, used on the Upper Cover, Bearing Bracket, & M. Seal Bracket of our pumps. (L-200A/250A/300B only)
- POWER-SAVING & HIGH-EFFICIENCY ALBC3 (Aluminum Bronze) IMPELLER : Utilizes wear-resistant and anti-corrosion ALBC3 (Aluminum Bronze) Impeller, the same material as the propellers of boats and vessels.
- Robust construction and compact design with a dry motor, double mechanical seals and impeller flow guide vane for high efficiency.
- Pump manufactured with heavy duty housing, cable leads are isolated by hardened epoxy for water proofing, and double mechanical seals.
- High solids, epoxy coating prolongs metals from corrosion and oxidization.
- L Series are equipped with Sacrificial Anode. Sacrificial Anode are create from a metal alloy with a more negative electrochemical potential. Sacrificial Anode are highly active metals, that are used to prevent pump material surface from corroding.

APPLICATIONS

- Aquiculture water pumping and drainage, for large volume water applications.
- Water supply for landscape, water features, cooling in the power plant or drainage for industry.
- Water extraction from rivers, lakes and reservoirs.
- Flood control or used for large volume dewatering.
- Others : Extraction of water from dock and river.



L-405A/41A



L-62A/63A



L-200A/250A



L-300B



SACRIFICIAL ANODE

PRODUCT NOMENCLATURE

L	—	4	1	A
Type		Discharge inch	HP	Style
L	—	200	A	
Type		Discharge inch	Style	

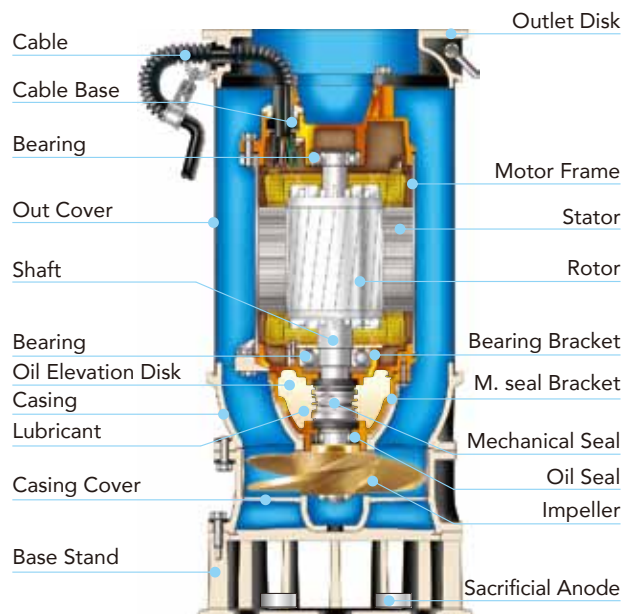



PERFORMANCE CURVES

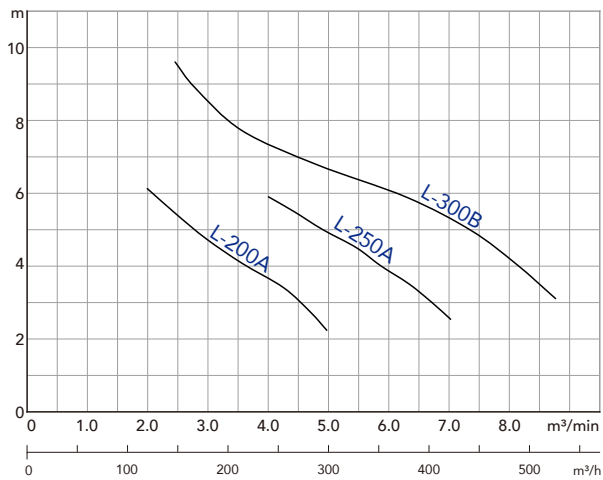
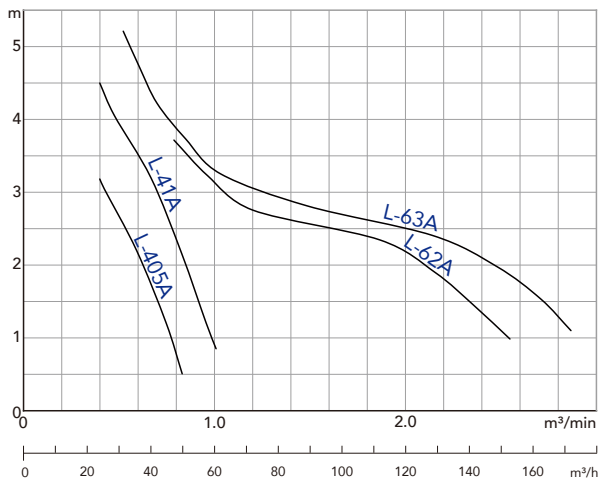

SPECIFICATIONS

Item		Description
Limits of Use	Liquid Temp.	0~40°C (32~104°F)
	Applications	Agriculture irrigation • Agriculture water • River water
Type	Frequency	50Hz
	Motor	2P (3000rpm:0.5~1HP) • Dry Motor 4P (1500rpm:2~15HP) • Dry Motor
	Insulation	Class B (0.5~1HP) • Class F (2~3HP) • Class H (7.5~15HP)
	Protection	IP68
	Protector	Auto-cut (0.5~3HP) • None (7.5~15HP)
	Bearing	Ball type
	M.seal	Double M.seals
Material	Impeller	Axial (0.5~10HP) • Mixed flow (15HP)
	Outer Cover	SUS304
	Upper Cover	FC200 (0.5~3HP) • BC6 (7.5~15HP)
	Motor Frame	FC200 (0.5~3HP) • SUS304 (7.5~15HP)
	Shaft	SUS304
	M.seal	CA/CE & SiC/SiC (0.5~3HP) CA/CE & CA/CE (7.5~15HP)
	Casing	FC200
	Impeller	ALBC3
	Strainer	SUS304
	Cable	VCT or H07RN-F or SOW/STOW
Optional	Pumps can be customized to fit specifications	

PERFORMANCE SPECS.

Model	Output HP(kW)	Discharge Inch(mm)	Phase Ø	Start Method	Head m	Standard		Solid Passage mm	Weight kg		Dimensions mm		
						m³/min	m³/h		1Ø	3Ø	A	1Ø B	3Ø
L-405A	0.5(0.4)	3.5"(90) 4"(100)	1 3	Capacitor Direct	1.5	0.7	42	10	25	25	225	478	478
L-41A	1(0.75)	3.5"(90) 4"(100)	1 3	Capacitor Direct	3.0	0.7	42	10	26	26	225	478	478
L-62A	2(1.5)	6"(150)	3	Direct	2.0	2.0	120	20	-	51	305	-	597
L-63A	3(2.2)	6"(150)	3	Direct	2.5	2.0	120	20	-	52	305	-	597
L-200A	7.5(5.5)	8"(200)	3	Direct	4.0	3.5	210	22	-	116	340	-	923
L-250A	10(7.5)	10"(250)	3	Direct	4.0	5.5	330	22	-	157	380	-	1029
L-300B	15(11)	10"(250) 12"(300)	3	Direct	5.0	7.0	420	33	-	198	430	-	1082

Note : Weight Without Cable & Outlet,
*3.5" (90mm) optional by request.

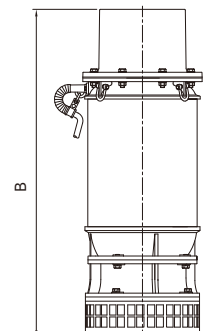
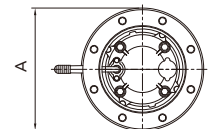

Optional Outlet Set

PRODUCT NOMENCLATURE

L2F	4	(3.5)	— 175 — 180	LKF	— 6	125	*	125	LOF	— 4	127
Type	Discharge (upper flange)	Discharge (lower flange)	PCD	Type	Discharge	PCD (upper flange)		PCD (lower flange)	Type	Discharge	PCD

Optional Outlet for IC-32B~45B



Optional Outlet for IC-32B~45B \ L405A~L-41A



Optional Outlet for IC-48~610



Optional Outlet for L-62A&L-63A



IC Series Submersible Dewatering Pumps		Standard Specifications		Threaded Outlet Specification
Model	Specifications	Double Flange Set		
IC-32B	2HP*3"	L2F3-145-160		3" Discharge / PF thread
IC-33B	3HP*3"			
IC-43B	3HP*3.5"	L2F4(3.5)-175-180		3.5" Discharge / PF thread
	3HP*4"	L2F4-165-190		4" Discharge / PF thread
IC-45B	5HP*3.5"	L2F4(3.5)-175-180		3.5" Discharge / PF thread
	5HP*4"	L2F4-165-190		4" Discharge / PF thread
		THREAD CONNECTION	FLANGE CONNECTION	DOUBLE FLANGE SET
IC-48	7.5HP*4"	LOT4-127	LOF4-175-190*127	LKF4-175*127
IC-410	10HP*4"			
IC-68	7.5HP*4"	LOT6-127	LOF6-240*127	LKF6-240*127
IC-610	10HP*6"			

L Series Large Volume Submersible Pumps		Standard Specifications		Threaded Outlet Specification
Model	Specifications	Double Flange Set		
L-405A	0.5HP*3.5"	L2F4(3.5)-175-180		3.5" Discharge / PF thread
	0.5HP*4"	L2F4-165-190		4" Discharge / PF thread
L-41A	1HP*3.5"	L2F4(3.5)-175-180		3.5" Discharge / PF thread
	1HP*4"	L2F4-165-190		4" Discharge / PF thread
L-62A	2HP*6"	6" Female thread		-
L-63A	3HP*6"	6" Female thread		-
L-200A	7.5HP*8"	Including : LOP8-285		-
L-250A	10HP*10"	Including : LOP10-325		-
L-300B	15HP*10"	Including : LOP10(12)-389		-
	15HP*12"	Including : LOP12-389		-

※ The LOP PVC Pipe is a regular accessory and it is built in L-200A, L-250A and L-300B.

IP6 PVC Pipe is optional accessory for purchase for L-62A and L-63A.

Lower Flange and Double Flange are optional accessories for purchase for IC-32B/33B/43B/45B, L-405A and L-41A.

Hose Connection, Thread Connection, Flange Connection and Double Flange Set are optional accessories for purchase for IC-48, IC-68, IC-410 and IC-610.

CASING COVER

<p>IC-32B • 33B</p>	<p>IC-43B • 45B</p>	Model	mm			Bolt Size
		IC-32B IC-33B	DA	DB	DC	M12x25L
		IC-43B IC-45B	80	125	150	M12x25L
			<p>IC-48 • IC-410 • IC-68 • IC-610</p>			
		IC-48 IC-410	87	150		M12x25L
		IC-68 IC-610	97	175		M12x25L

HIGH SOLIDS EPOXY COATING

- HIGH SOLIDS EPOXY COATING is a concoction of special epoxy resin, hardener, chemical-tolerant paint, with superior water/vapor transmission rate. It features high density and high anti-corrosion capability and is particularly effective for and can be firmly attached to metals like iron and steel to form an anti-corrosion layer on their surface. Furthermore, it can penetrate and attach to the already-rusty surface of a metal. It has proven to be able to effectively prevent and protect metals from corrosion and oxidization.
- HCP HIGH SOLIDS EPOXY COATING is an ecological paint of very high solid content and very low content of solvent. Its dry film thickness can reach 100µm and above, compared to a regular paint whose dry film thickness is merely 30µm. The extraordinary toughness, anti-abrasion properties, plus excellent resistance to chemicals and sea water make it widely acclaimed and adopted as the best solution in the industry.
- HCP has been a pioneer in the pump industry as well as the first one to apply HIGH SOLIDS EPOXY COATING to our IC & L Type and pumps above 7½ HP . Such innovative improvement will offer extended protection for our pumps and prolong their life expectancy substantially.



Sacrificial Anode Protection System

- Corrosion, the arch enemy for metals, especially when the metal is sunk in brine or sea water, could cause electrolysis and accelerate the corrosion. The pump in sea water normally suffers from rapid corrosion which causes the damage to its components.
- For better protection against brine-inflicted corrosion, we suggest application of Sacrificial Anode Plate to the pump. Sacrificial Anode Plate will release positive particles and turn the pump into negative. The positive Sacrificial Anode will dissolve slowly in sea water and release electrons which can prevent the oxidization of the pump until it is exhausted. During the process, Sacrificial Anode Plate will protect the pump and its components from corrosion for an extended period of time and prolong the pump's life expectancy. If the pump is intended to be operated in sea water for more than 4 hours a day, the use of Sacrificial Anode is strongly recommended as it can offer extra protection against the corrosion of sea water and effectively extend the life expectancy of the pump.

* Entire L Series are equipped with Sacrificial Anode. Sacrificial Anode would be optional for other models.





Without Sacrificial Anode Plate, frame and cover were seriously eroded by sea water in just five months of use.



After five months of operation, the corrosion of cast iron components has been alleviated (refer to below photo), while the Sacrificial Anode Plate was gradually worn out. Recommendation : Replace the Sacrificial Anode Plate when 3/4 of the plate is worn out.

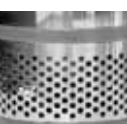

Sacrificial Anode Specifications

Model	Applicable Pump	Installation	Quantity
Z-80*30*M10	L-405A ~ 63A (Standard)		1
	L-300B (Standard)		2
AC-LR80C	L-200A ~ 250A (Standard)		2
AC-LR80A	IC-215 (Optional)		1
AC-R80	IC-32B ~ 45B (Optional)		1
	IC-48 ~ 610 (Optional)		2



ACCESSORIES :

Adapter / Check Valve

IC series' strainer and base can be removed and equipped with Adapter or Check Valve instead. And thus IC Series can be installed on land.

PRODUCT FEATURES



Epoxy Cable Base

An epoxy resin seal cable base prevents moisture from entering the motor through the core wires.





Auto-cut Protector

Automatic On/Off motor protector to prevent motor burn out due to high temperature and excess amperage draw.(There's no autocut for Pump above L-200A.)



Mechanical Seals

Double mechanical seal have two waterproof sliding surface and provide best seal effect. Silicon carbide / Silicon carbide which is abrasion resistance and could be operation for long-term (it's optional from L-200A to L-300B).



Food Grade Lubricant

High level of medical & food grade white mineral oil; it's harmless to creatures and environment.It's harmless to plant for agriculture and fishes/shrimps for aquaculture. Meanwhile, it can meet the demand of high quality safety purpose.



High Efficiency Dry Motors

All stator coils need to be treated with insulating varnish procedure to achieving the best insulation, efficiency and durability.



Professionalism • Innovation • Service • Commitment
HCP PUMP MANUFACTURER CO., LTD.
www.hcppump.com



Distributor: