

EQ SERIES®

COMMERCIAL PLASTIC PUMP WITH AND WITHOUT HAIR AND LINT STRAINER



EQ Series TEFC Pump with Strainer



EQ Series Pump without Strainer

Commercial Plastic pump built specifically for commercial and large residential pools. Pump features electrical and hydraulic designs that helps reduce electrical costs, less wear and tear on critical moving parts, and quiet operation.

CALIFORNIA PROPOSITION 65 WARNING
 ⚠️ **WARNING:** Cancer and Reproductive Harm.
 ⚠️ **AVERTISSEMENT:** Peut Causer le Cancer et des Dommages au Système Reproducteur.
 ⚠️ **ADVERTENCIA:** Cáncer y Daño Reproductivo.
www.p65warnings.ca.gov

Featured Highlights

- Efficiency 3-phase motors
- Commercial grade, non-corrosive Plastic Parts for durability and long life
- Now available in TEFC and ODP 3-phase motor options
- Cam and Ramp™ See -Through Lid
- Self-priming with Hair and Lint Strainer
- Light weight
- 3-phase models compatible with Acu Drive™ XS VF Drive
- Drop-in replacement for C Series® and CSP Series™ Pumps
- Waterfall models great for low head, high flow applications
- Easy cleaning and serviceability
- 50 Hz models available -contact factory

Ordering Information

Product	Description	Voltage	Amps	HP	SF	SFHP	Primary Listings and Certifications [®]	Port Size (ANSI Flange)	Motor Class	Carton Wt. (Lbs.)	Curve Key
PREMIUM EFFICIENCY SINGLE PHASE POOL PUMP WITHOUT STRAINER - ODP											
▶ 340019	EQ-500	230	20.0	5	1.15	5.75	NSF ² , ETL ⁵	6 in. x 4 in.	F	97	A
▶ 340021	EQ-750	230	30.4	7.5	1.15	8.63	NSF ²	6 in. x 4 in.	F	132	B
▶ 340237	EQ-1000	230	40.0	10	1.15	11.50	NSF ²	6 in. x 4 in.	F	125	C
NEMA RATED PREMIUM EFFICIENCY THREE PHASE POOL PUMP WITHOUT STRAINER - ODP											
▶ 340020	EQK-500	208-230/460	13.5-12.3/6.2	5	1.15	5.75	NSF ²	6 in. x 4 in.	F	77	D
▶ 340022	EQK-750	208-230/460	20.4-18.2/9.1	7.5	1.15	8.63	NSF ²	6 in. x 4 in.	F	87	E
▶ 340023	EQK-1000	208-230/460	27.0/26.2-13.1	10	1.15	11.50	NSF ²	6 in. x 4 in.	F	117	F
▶ 340024	EQK-1500	208-230/460	40.0-38.0/18.8	15	1.15	17.25	NSF ²	6 in. x 4 in.	F	132	G
NEMA RATED PREMIUM EFFICIENCY THREE PHASE POOL PUMP WITHOUT STRAINER - TEFC											
▶ 340608	EQKT-500	208-230/460	13.4-12.2/6.1	5	1.25	6.25	NSF ² , UL ⁷	6 in x 4 in	F	97	D
▶ 340609	EQKT-750	208-230/460	19.9-17.8/8.9	7.5	1.25	9.38	NSF ² , UL ⁷	6 in x 4 in	F	117	E
▶ 340610	EQKT-1000	208-230/460	26.4-23.5/11.7	10	1.25	12.50	NSF ² , UL ⁷	6 in x 4 in	F	163	F
▶ 340611	EQKT-1500	208-230/460	39.0-36.0/18.0	15	1.25	18.75	NSF ² , UL ⁸	6 in x 4 in	F	177	G
NEMA RATED PREMIUM EFFICIENCY THREE PHASE POOL PUMP WITHOUT STRAINER - 575 VOLT - ODP											
▶ 340148	EQK-500	575	5.1	5	1.15	5.75	NSF ²	6 in. x 4 in.	F	77	D
▶ 340149	EQK-750	575	7.2	7.5	1.15	8.63	NSF ²	6 in. x 4 in.	F	87	E
▶ 340150	EQK-1000	575	10.2	10	1.15	11.50	NSF ²	6 in. x 4 in.	F	117	F
▶ 340151	EQK-1500	575	15.0	15	1.15	17.25	NSF ²	6 in. x 4 in.	F	132	G
PREMIUM EFFICIENCY SINGLE PHASE POOL PUMP WITH STRAINER - ODP											
▶ 340030	EQ-500	230	20.0	5	1.15	5.75	NSF ³ , ETL ⁵	6 in. x 4 in.	F	126	A
▶ 340032	EQ-750	230	30.4	7.5	1.15	8.63	NSF ³	6 in. x 4 in.	F	161	B
▶ 340238	EQ-1000	230	40.0	10	1.15	11.50	NSF ³	6 in. x 4 in.	F	160	C
NEMA RATED PREMIUM EFFICIENCY THREE PHASE POOL PUMP WITH STRAINER - ODP											
▶ 340031	EQK-500	208-230/460	13.5-12.3/6.2	5	1.15	5.75	NSF ³	6 in. x 4 in.	F	106	D
▶ 340033	EQK-750	208-230/460	20.1-18.3/9.1	7.5	1.15	8.63	NSF ³	6 in. x 4 in.	F	116	E
▶ 340034	EQK-1000	208-230/460	27.0/26.2-13.1	10	1.15	11.50	NSF ³	6 in. x 4 in.	F	146	F
▶ 340035	EQK-1500	208-230/460	40.0-36.0/17.8	15	1.15	17.25	NSF ³	6 in. x 4 in.	F	161	G
NEMA RATED PREMIUM EFFICIENCY THREE PHASE POOL PUMP WITH STRAINER - TEFC											
▶ 340604	EQKT-500	208-230/460	13.4-12.2/6.1	5	1.25	6.25	NSF ³ , UL ⁷	6 in x 4 in	F	127	D
▶ 340605	EQKT-750	208-230/460	19.9-17.8/8.9	7.5	1.25	9.38	NSF ³ , UL ⁷	6 in x 4 in	F	147	E
▶ 340606	EQKT-1000	208-230/460	26.4-23.5/11.7	10	1.25	12.50	NSF ³ , UL ⁷	6 in x 4 in	F	193	F
▶ 340607	EQKT-1500	208-230/460	39.0-36.0/18.0	15	1.25	18.75	NSF ³ , UL ⁸	6 in x 4 in	F	207	G

▶ This product either meets or is exempt from the DOE Dedicated Purpose Pool Pump regulation. This product will remain available after the DOE regulation takes effect in July 2021.

EQ SERIES®

COMMERCIAL PLASTIC PUMP WITH AND WITHOUT HAIR AND LINT STRAINER

Product	Description	Voltage	Amps	HP	SF	SFHP	Primary Listings and Certifications ⁶	Port Size (ANSI Flange)	Motor Class	Carton Wt. (Lbs.)	Curve Key	
NEMA RATED PREMIUM EFFICIENCY THREE PHASE POOL PUMP WITH STRAINER - ODP - 575 VOLT												
▶ 340155	EQK-500	575	5.1	5	1.15	5.75	NSF ³	6 in. x 4 in.	F	106	D	
▶ 340156	EQK-750	575	7.2	7.5	1.15	8.63	NSF ³	6 in. x 4 in.	F	116	E	
▶ 340157	EQK-1000	575	10.2	10	1.15	11.50	NSF ³	6 in. x 4 in.	F	146	F	
▶ 340159	EQK-1500	575	15.0	15	1.15	17.25	NSF ³	6 in. x 4 in.	F	161	G	
SINGLE PHASE WATERFALL PUMP WITHOUT STRAINER - ODP - 1750 RPM												
▶ 340014	EQW-300	208-230	19.5/19.2	3	1.15	3.45	NSF ² , ETL ⁵	6 in. x 4 in.	F	97	H	
▶ 340017	EQW-500	208-230	23.0-20.1	5	1.25	6.25	NSF ² , ETL ⁵	6 in. x 4 in.	F	97	I	
NEMA RATED PREMIUM EFFICIENCY THREE PHASE WATERFALL PUMP WITHOUT STRAINER - ODP - 1750 RPM												
▶ 340016	EQWK-300	208-230/460	8.4-7.8/3.9	3	1.15	3.45	NSF ²	6 in. x 4 in.	F	77	H	
▶ 340018	EQWK-500	208-230/460	13.8-13.0/6.5	5	1.25	6.25	NSF ²	6 in. x 4 in.	F	77	I	
SINGLE PHASE WATERFALL PUMP WITH STRAINER - ODP - 1750 RPM												
▶ 340026	EQW-300	208/230	19.5/19.2	3	1.15	3.45	NSF ³ , ETL ⁵	6 in. x 4 in.	F	126	H	
▶ 340028	EQW-500	208-230	23.0/20.1	5	1.25	6.25	NSF ⁴ , ETL ⁵	6 in. x 4 in.	F	126	I	
NEMA RATED PREMIUM EFFICIENCY THREE PHASE WATERFALL PUMP WITH STRAINER - ODP												
▶ 340027	EQWK-300	208-230/460	8.4-7.8/3.9	3	1.15	3.45	NSF ³	6 in. x 4 in.	F	106	H	
▶ 340029	EQWK-500	208-230/460	13.8-13.0/6.5	5	1.25	6.25	NSF ⁴	6 in. x 4 in.	F	106	I	
HAIR AND LINT STRAINER WITH CAM AND RAMP LID, BASKET AND HARDWARE												
340013	EQ 6X6 Strainer						NSF ⁴	6 in. x 6 in.		33	J	
EQ SERIES PUMP ACCESSORIES FLANGE ASSEMBLY KITS												
357262	Flange 4 in. w/ gasket and SS hardware ¹	(See images on next page)									20	
357263	Flange 6 in. w/ gasket and SS hardware ¹	(See images on next page)									23	
357212	Flange 6 in. w/ gasket and SS hardware. For use on EQ Pumps without Strainer.										23	

See page 249 for an assortment of PS Series In-Line Strainers that work well with EQ Series pumps.

¹ Thermoplastic PVC socket style.

² 'NSF' indicates that pump bears a mark signifying evaluation to NSF Standard 50 For Non Self-Priming Centrifugal Pumps For Swimming Pools, Spas and Hot Tubs.

³ 'NSF' indicates that pump bears a mark signifying evaluation to NSF Standard 50 For Self-Priming Centrifugal Pumps For Swimming Pools, Spas and Hot Tubs.

⁴ 'NSF' indicates that product bears a mark signifying evaluation to NSF Standard 50 For Materials and Components.

⁵ 'ETL' indicates that pump bears a specific ETL mark signifying evaluation to U.S. Standards UL1081 for Permanently Connected Swimming Pool and Spa Pumps and to Canadian Standards CAN/CSA C22.2 No. 108-01 Liquid Pumps For Swimming Pools And Spas. (Enclosure 3).

⁶ Product may have been evaluated to other state and local regulatory standards. Listing status may change. Always confirm status with appropriate agency if in doubt.

⁷ 'UL' indicates that pump bears a UL mark signifying evaluation to U.S. Standards UL1081 for Permanently Connected Swimming Pool and Spa Pumps and to Canadian Standards CAN/CSA C22.2 No. 108-01 Liquid Pumps For Swimming Pools Only (Enclosure 3).

⁸ 'UL' indicates that pump bears a UL mark signifying evaluation to U.S. Standards UL1081 for Permanently Connected Swimming Pool and Spa Pumps.

Dimensions and Performance - See next page.

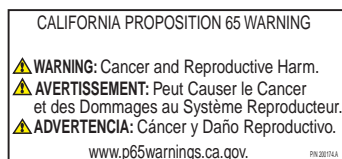

See pages 530–531 for replacement parts.

EQ SERIES®

COMMERCIAL PLASTIC PUMP WITH AND WITHOUT HAIR AND LINT STRAINER (CONT'D)

Dimensions and Performance

Single Phase Pumps - EQ Models

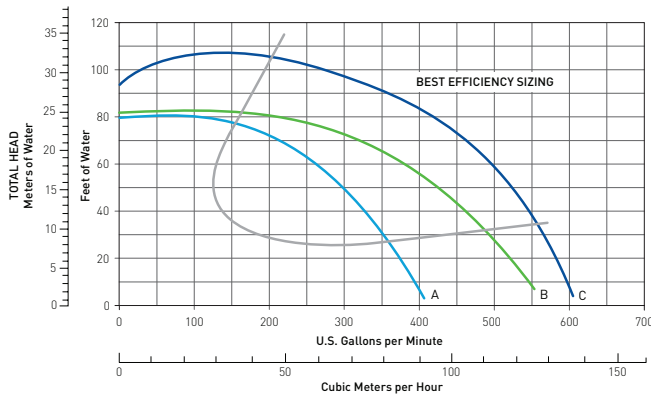

EQ Strainer Only

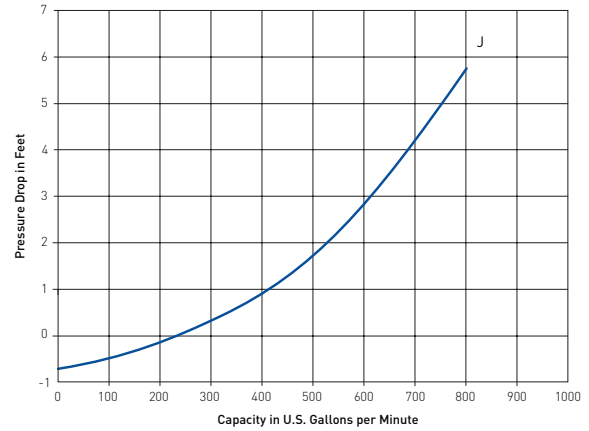

Three Phase Pumps - EQK Models

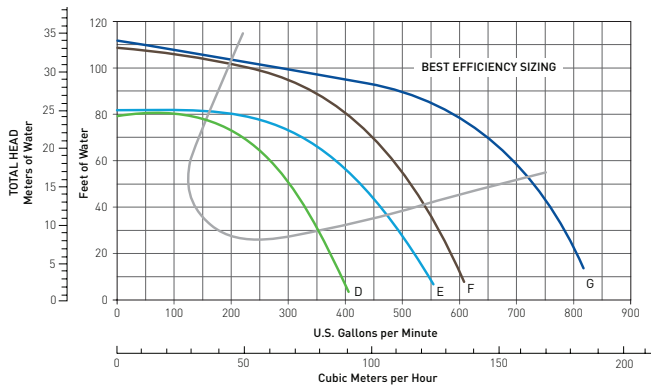

WaterFall Pumps - EQW & EQWK Models

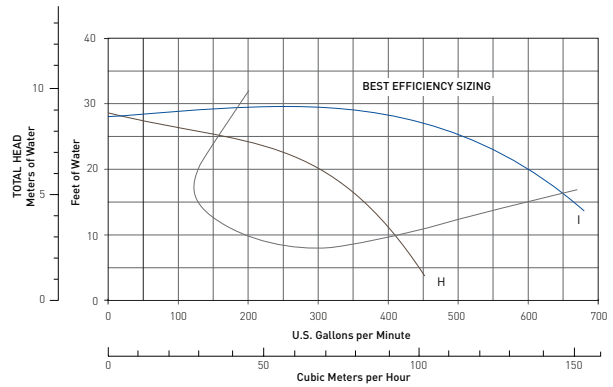

For detailed efficiency curves go to www.pentaircommercial.com

EQ SERIES®

COMMERCIAL PLASTIC PUMP WITH AND WITHOUT HAIR AND LINT STRAINER

(CONT'D)

Dimensions and Performance

EQ Series Commercial Pump without Strainer

EQ Series Pump Flange Assembly Kit

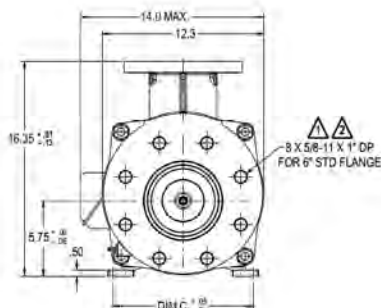
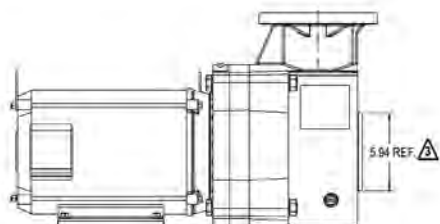
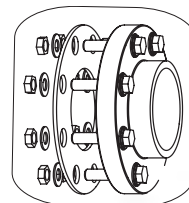
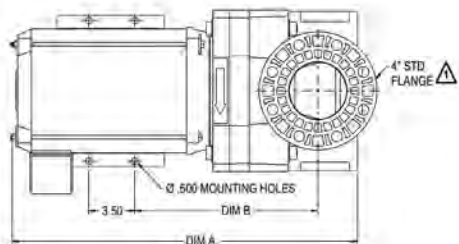

EQ Series Commercial Pump with Strainer

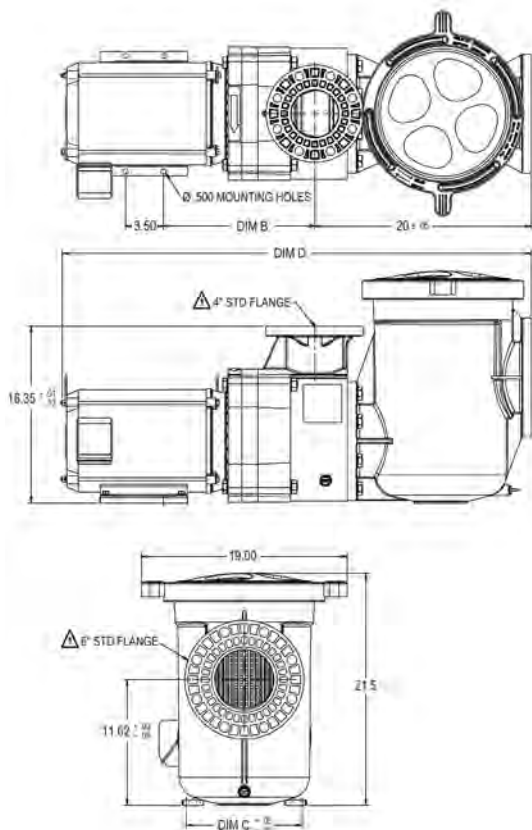

Product No W/O Pot	Product No. W/ Pot	Dim A*	Dim B*	Dim C*	Dim D*
340014	340026	26.62	13.32	9.69	43.59
340017	340028	26.62	14.21	9.69	43.59
340019	340030	26.62	13.32	9.69	43.59
340021	340032	27.53	14.21	10.69	44.59
340237	340238	26.94	14.03	10.69	43.92
340016	340027	23.12	13.32	9.69	40.09
340018	340029	23.12	13.32	9.69	40.09
340020	340031	23.12	13.32	9.69	40.09
340022	340033	24.50	13.32	9.69	41.56
340023	340034	26.31	14.38	10.69	43.29
340024	340035	26.31	14.38	10.69	43.29
340148	340155	24.62	13.32	7.50	41.59
340149	340156	24.62	13.32	7.50	41.59
340150	340157	26.31	14.07	8.50	43.29
340151	340159	26.31	14.07	8.50	43.29
340608	340604	24.52	13.48	9.69	41.50
340609	340605	26.52	14.19	10.69	43.50
340610	340606	28.02	14.19	10.69	45.00
340611	340607	28.02	14.19	10.69	45.00
340086	340082	24.62	13.48	9.69	41.59
340085	340081	24.62	13.48	9.69	41.59
340084	340080	28.31	14.19	10.69	45.29
340083	340049	28.31	14.19	10.69	45.29
340048	340046	28.31	14.19	10.69	45.29
340047	340045	28.31	14.19	10.69	45.29

* This value may vary slightly depending upon manufacturer and motor design.

- ▲ FASTENERS AND O-RING ARE INCLUDED WITH PENTAIR POOL PRODUCTS EQ 6X6 STRAINER TO CONNECT STRAINER DIRECTLY TO EQ SERIES PUMP. IF PUMP IS TO BE INSTALLED WITHOUT STRAINER MAKE BOTH CONNECTIONS PER NOTE 1.
- ▲ USE ANSI CLASS 150 PLASTIC FLANGE AND 1/8 in. THICK CLASS 150 FULL FLANGE GASKET TO MAKE CONNECTION.
- ▲ THIS DIAMETER FITS INSIDE 6 in. SCH 40 PIPE. DO NOT USE SCH 80 PIPE AS FINAL PIPE SIZE WHEN MAKING THIS FLANGE CONNECTION.

See pages 530–531 for replacement parts.